

Development of new furnace technologies (H₂, electric, blend) and constraints



Malte Sander

ICG Spring School
Lloret de Mar

April 30, 2024

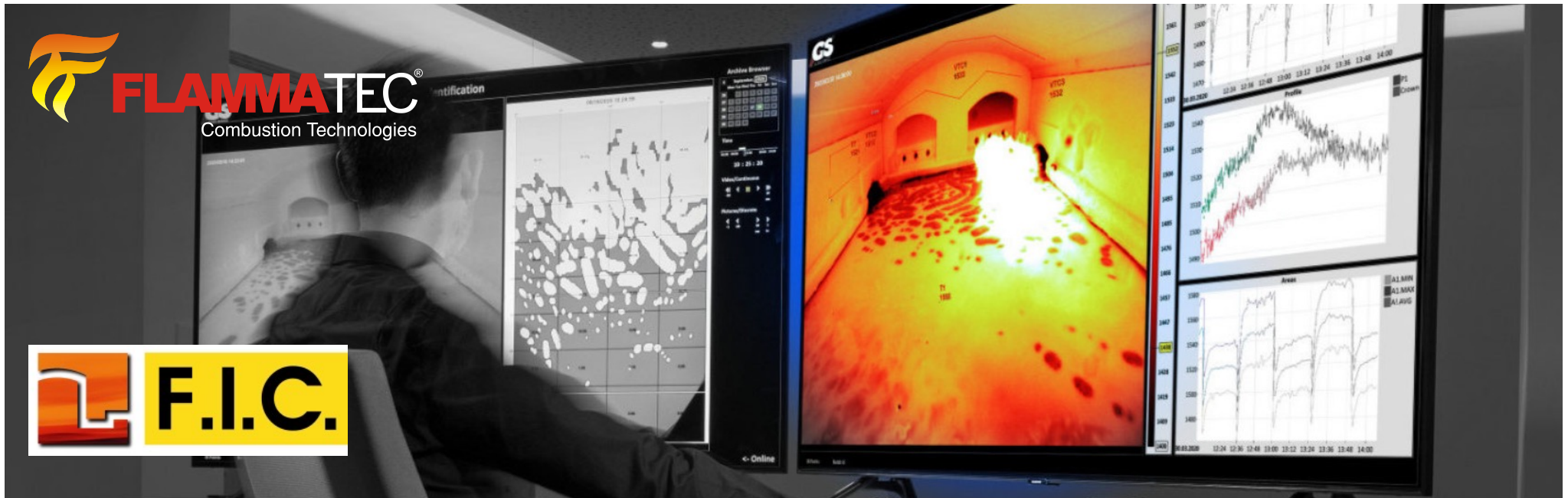

ASSESSMENT

SMART PROCESS CONTROL

PRODUCTS



SIMULATIONS

3D advanced CFD simulation of the complete high temp. glass melting process for regenerator, melter, forehearth and forming. more



LAB SERVICES

Quick identification of glass defects and their origin to support quality improvements and operating parameter optimization. more



AUDITS & DATA ANALYSES

Analyzing production, observing critical conditions and identifying optimization potential. more

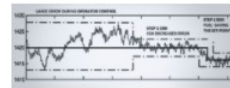

EXPERT SYSTEM *ES III*TM

Full automatic process control resulting in stable operations, improved yield, reduced production costs and emissions. more



CAMERAS & SENSORS

Smart AR sensors such as Camera systems in the Visible and NIR spectrum, simultaneously and on one chipset, compatible with Expert System. more



ENGINEERING

Turn-key design and supply of specialized furnaces with high quality demands (for lenses, LCD or crystal). more



RAW MATERIALS

Provide glass producers with Commodities, Specialties, Rare Earth Oxides and Polishing Compounds. more



Together
we shape a
carbon-neutral
glass industry,
for a **brighter future**

How much energy is needed
to produce glass?

In a glass furnace, raw materials are transformed into glass and heated up.
The glass melt leaves the furnace at a temperature of T_{ex} .

Enthalpy of the melt at T_{ex} .

$$H_{ex} = (1 - y_{cullet}) \cdot \Delta H_{chem}^0 + \Delta H(T_{ex})$$

Cullet fraction in the batch.

Energy demand to transform the
raw materials into glass (at 25°C)

Energy demand to heat up the
glass from 25°C to T_{ex} .

Energy input
Combustion + electric

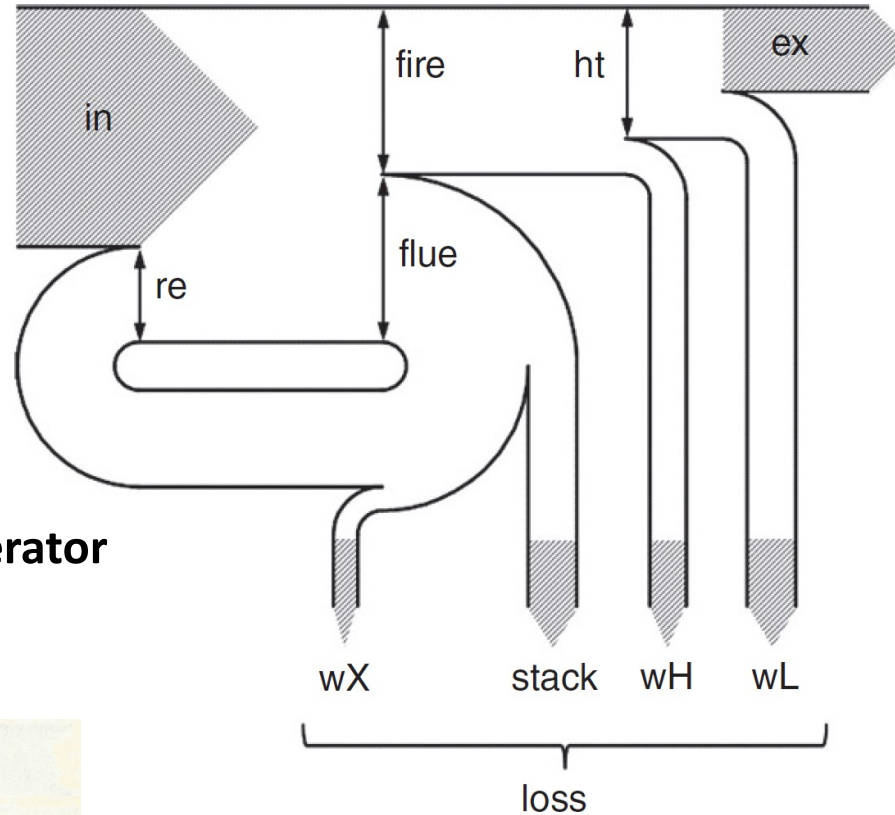

Exploited energy
Glass at throat
after conversion

**Invention of the regenerator
technology in 1856 by
Friedrich Siemens**

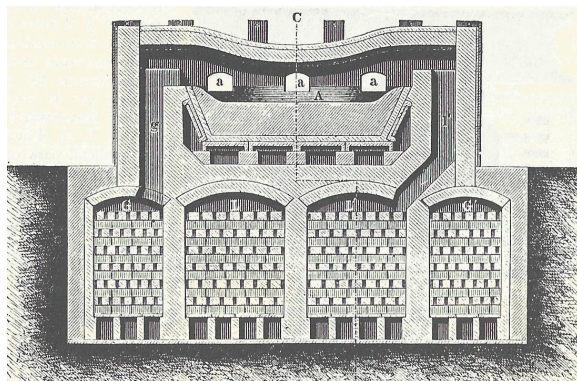

[source: Physics and Modeling of Glass Furnaces; Conradt, Muijsenberg, 2021]

[https://upload.wikimedia.org/wikipedia/commons/a/ad/Siemens-Martin_converter.jpg]

1930 SED at 20 GJ/t

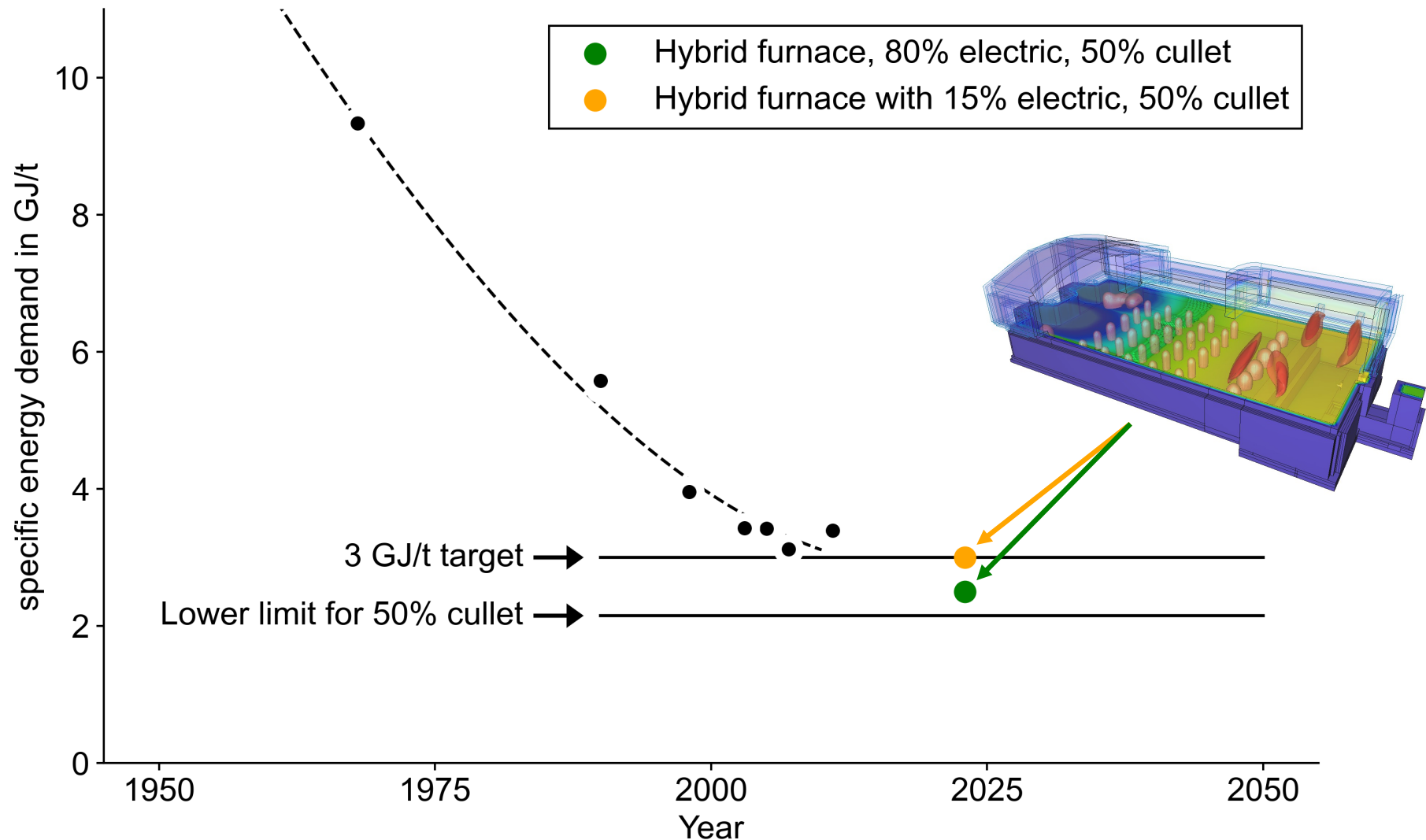

[data: An improved solution for oxy-fuel fired glass melting furnaces, Lindig]

[data: Prospects and physical limits of processes and technologies in glass melting, Conradt]

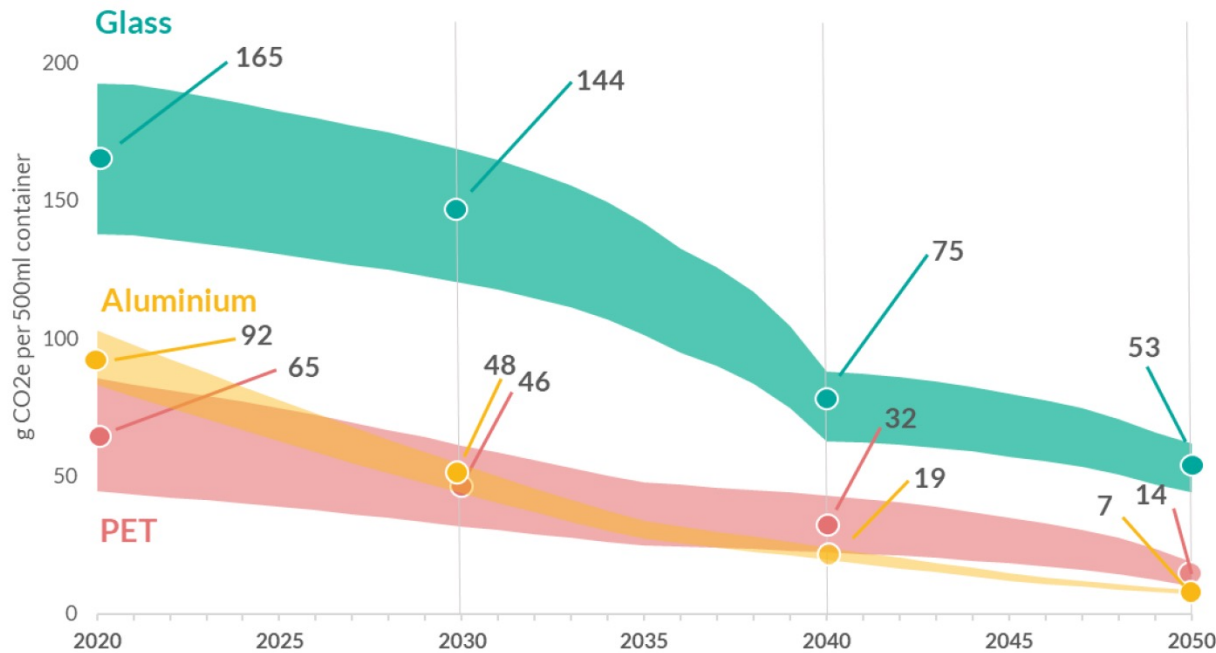

- Still significant CO₂e in 2050.
- 2-3 times higher CO₂e emissions for glass production than PET and aluminum.

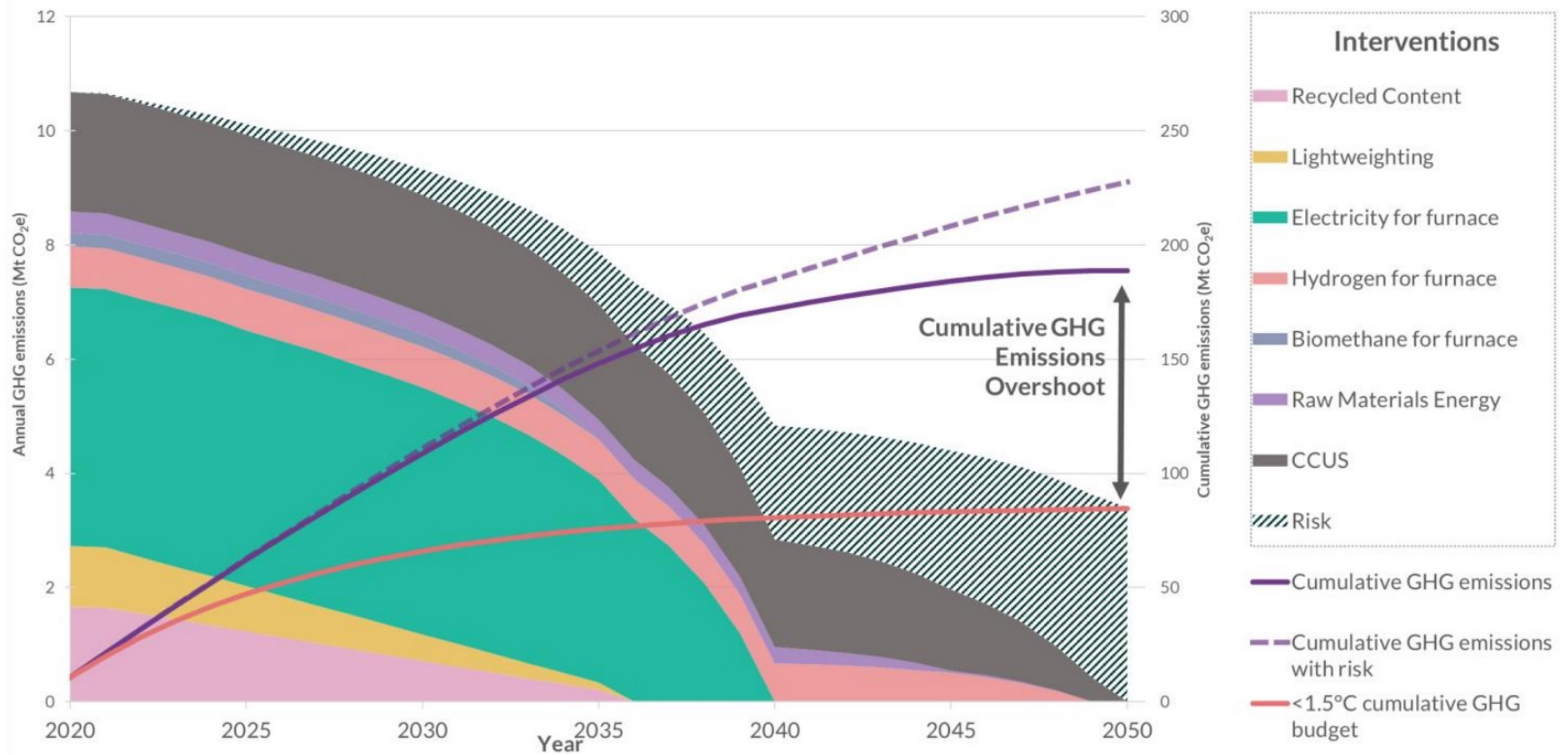

[Study: Decarbonisation of Single Use Beverage Packaging, Zero Waste Europe]

Decarbonization by electrification

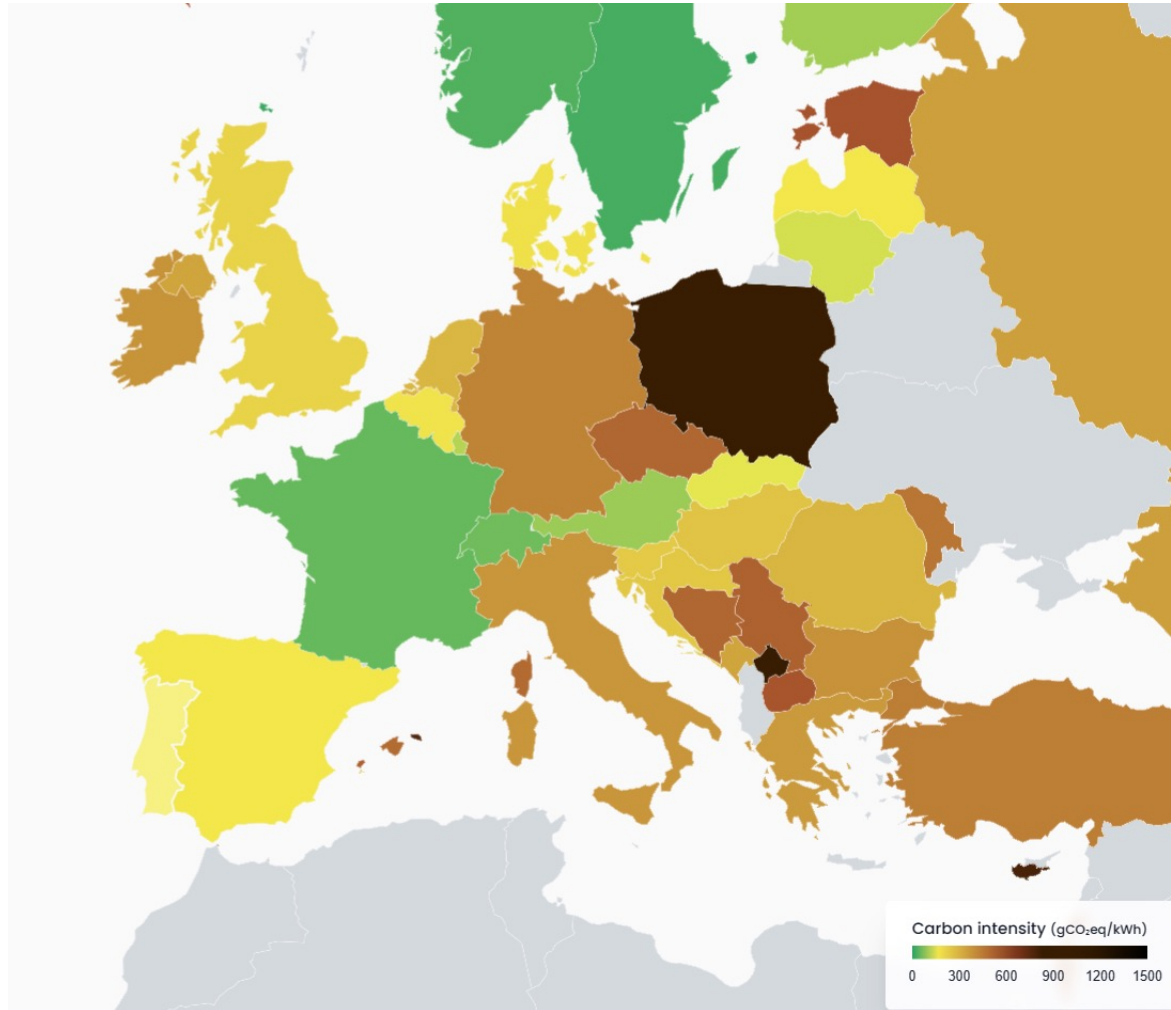

In many European countries coal and natural gas are used to generate electricity.

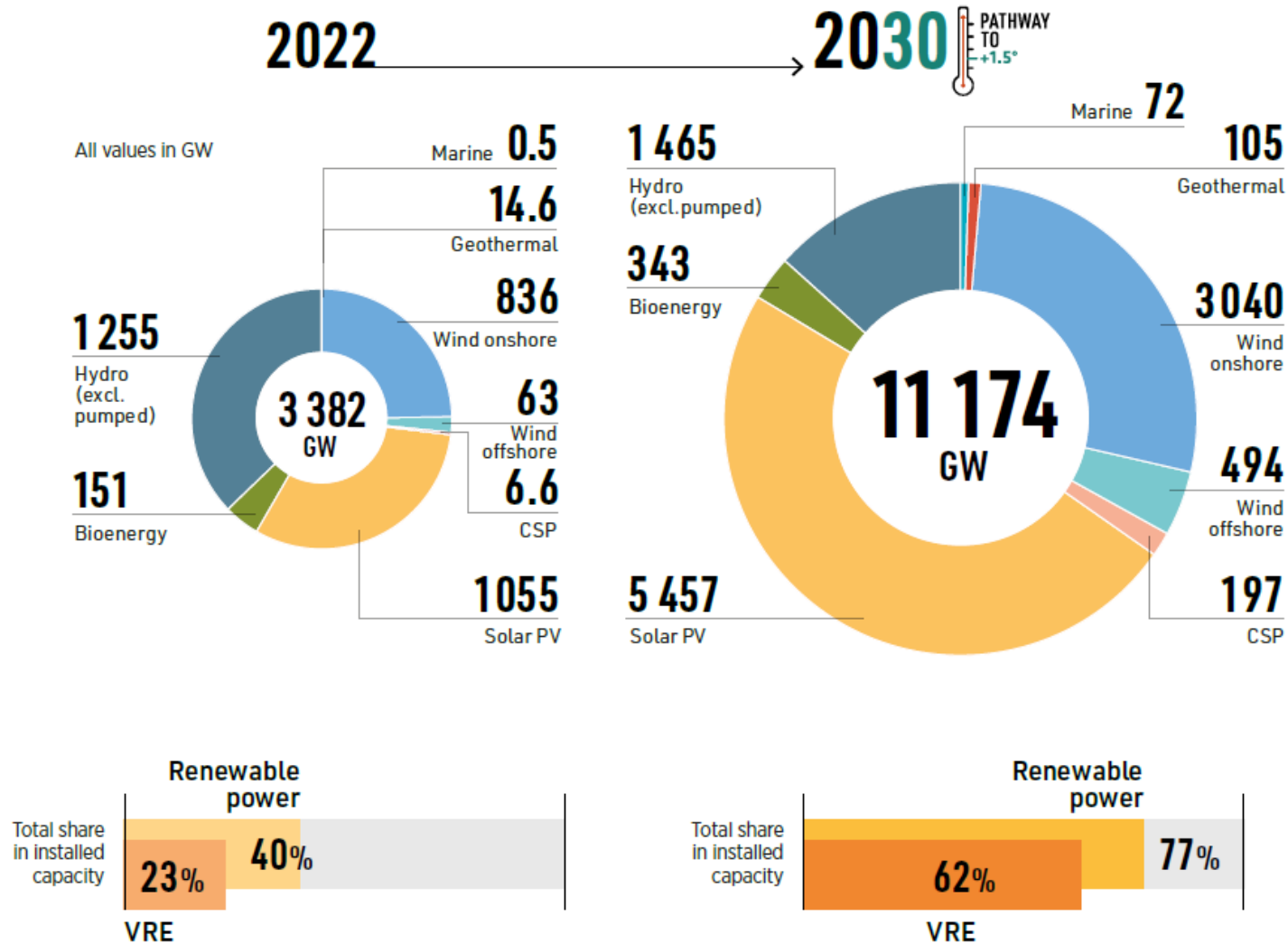

Notes: CSP = concentrated solar power; GW = gigawatt; PV = photovoltaic; VRE = variable renewable energy. Bioenergy includes biogas, biomass waste and biomass solid.

Based on: (IRENA, 2023a).

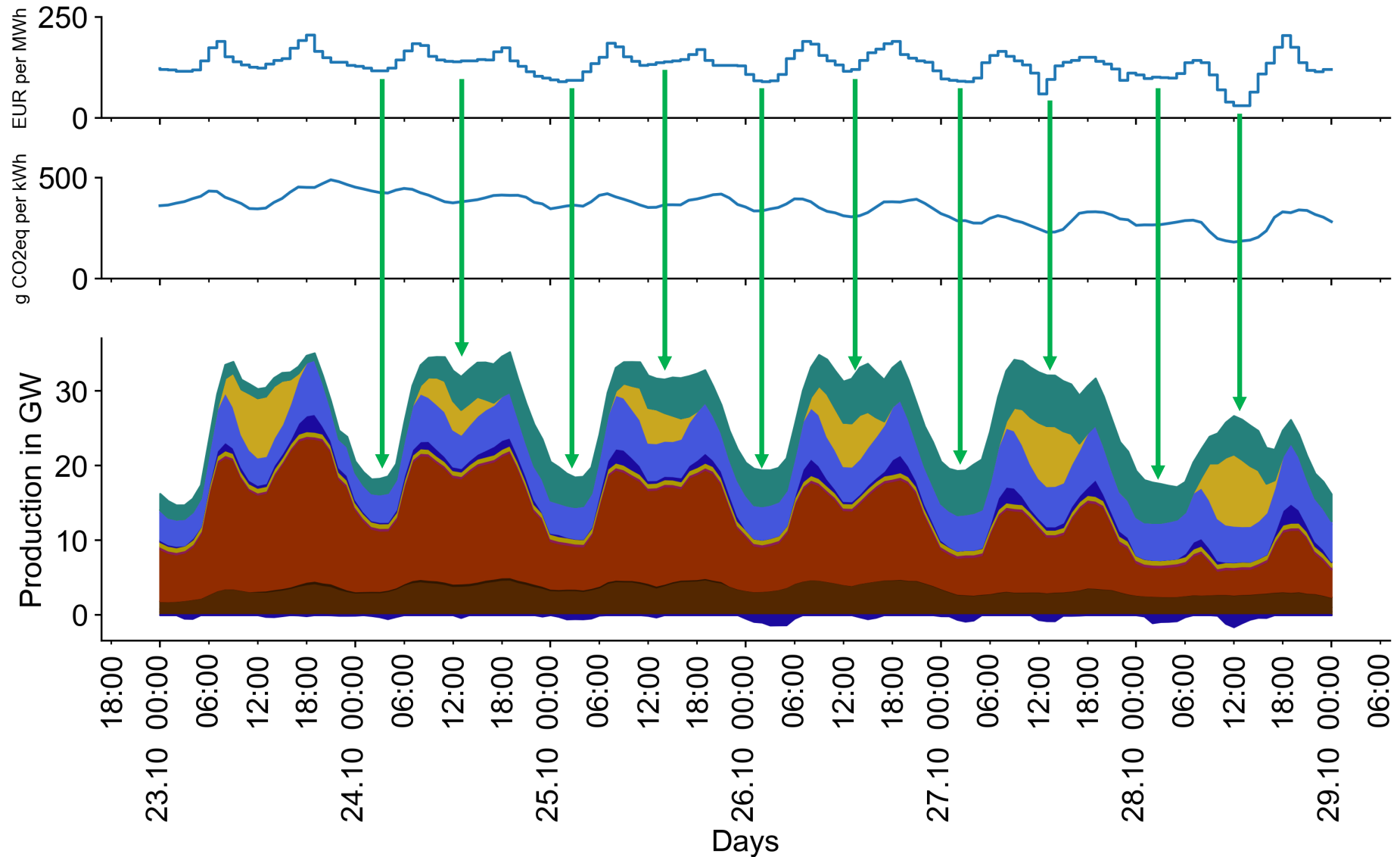

[data: <https://transparency.entsoe.eu/>]

- Variable energy supply requires adjustments in energy consumption to ensure a stable grid.
- The glass industry could reduce electric energy consumption during peak-demand hours.
- At high variable renewable energy supply, the glass industry could increase electric energy consumption and benefit from lower energy costs.
- Advanced furnace control is needed to stabilize glass temperatures.
- ESIII, our model predictive control software, uses multiple input parameters to calculate the best combination between fuel and electricity.
- Over ESIII 400 installations worldwide.

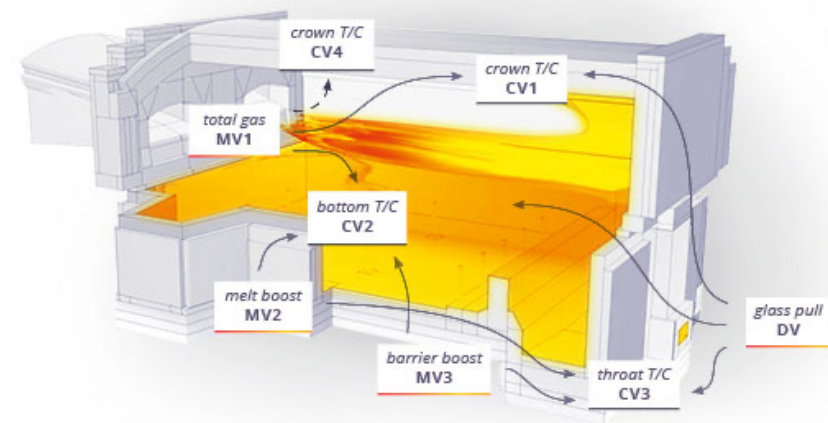

Green hydrogen as an alternative fuel

- Green hydrogen must be produced from renewable energy.
 - Proton exchange membrane (PEM) electrolyzers have fast response times and can be added to the energy grid to buffer peak supply and stabilize the grid frequency.
 - PEM electrolyzers are expensive. For an economic production, a high utilization rate is needed.
 - In the next years only small sandbox projects will be realized. Therefore, hydrogen is not available for all industries.
 - It will take decades to build a comprehensive hydrogen network.
-
- The glass industry could use green hydrogen as energy carrier.
 - Other industries need hydrogen as feedstock.
 - Steel industry could use hydrogen in the direct ore reduction as feedstock and energy carrier.

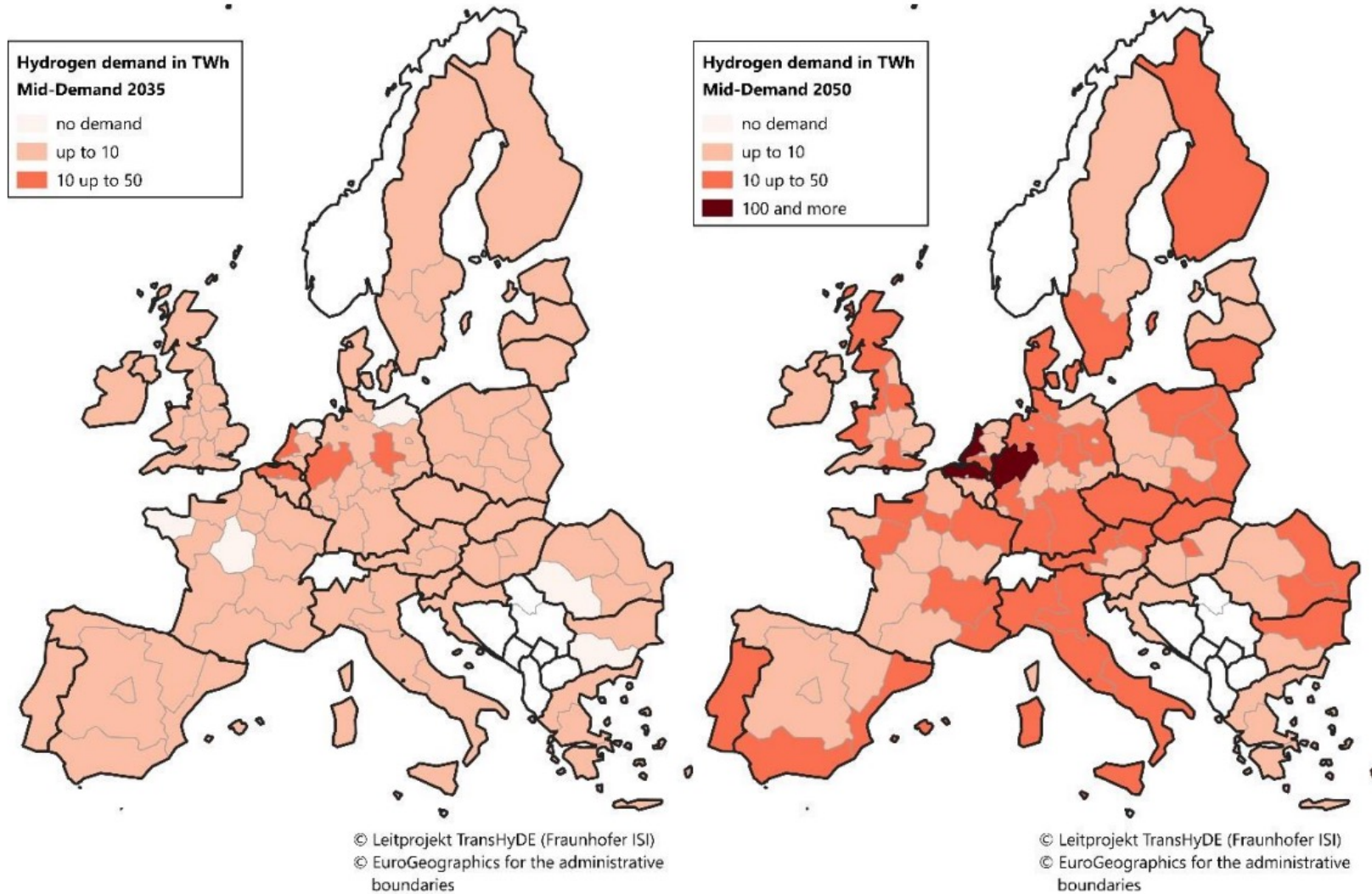

Mid_Demand

High_Demand

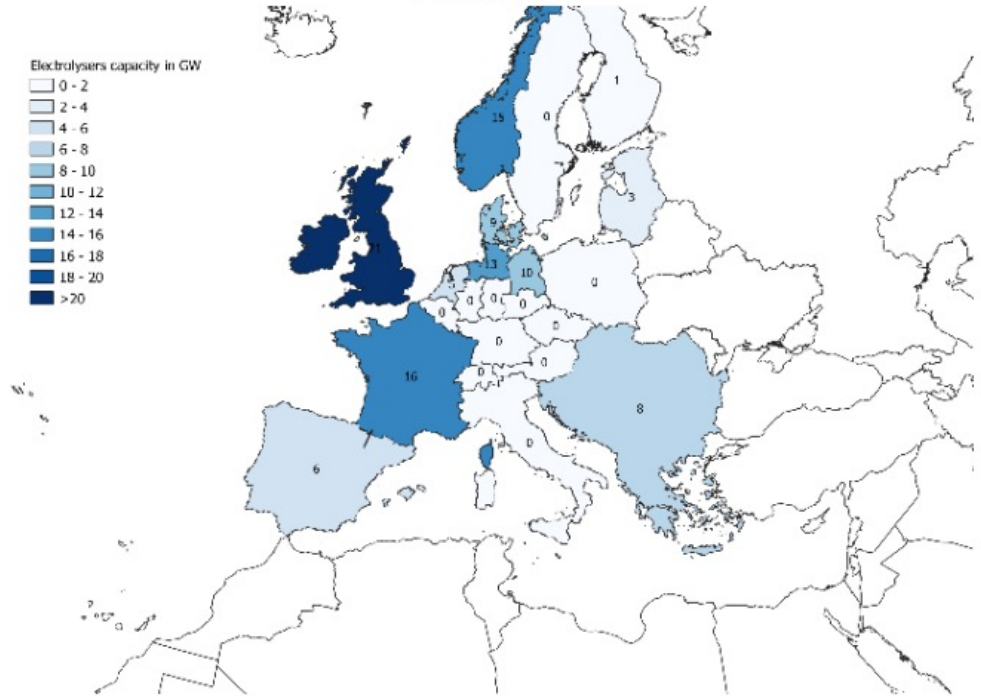
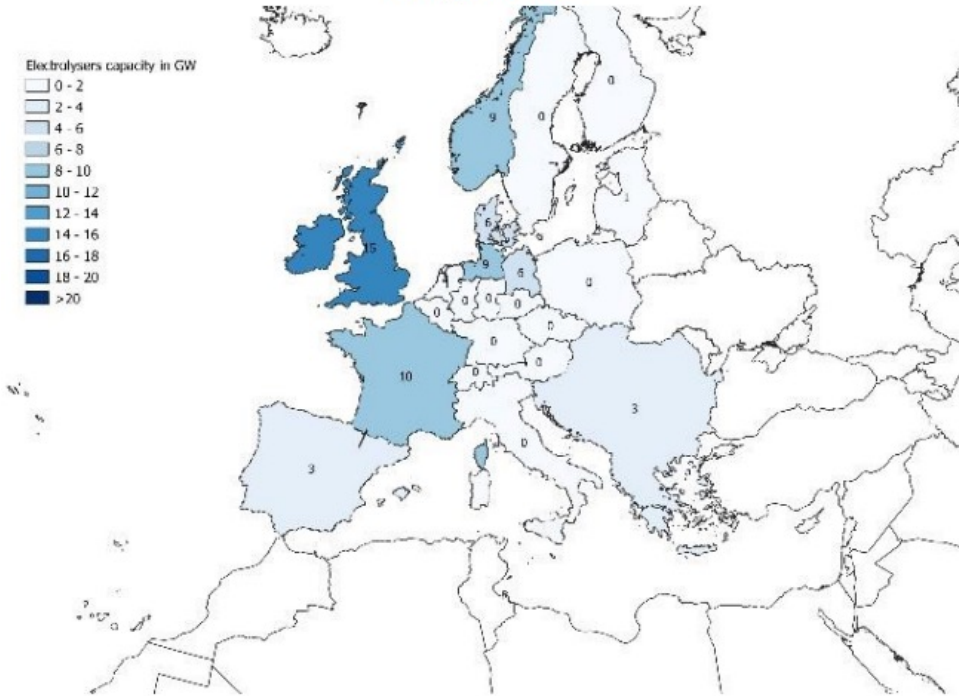

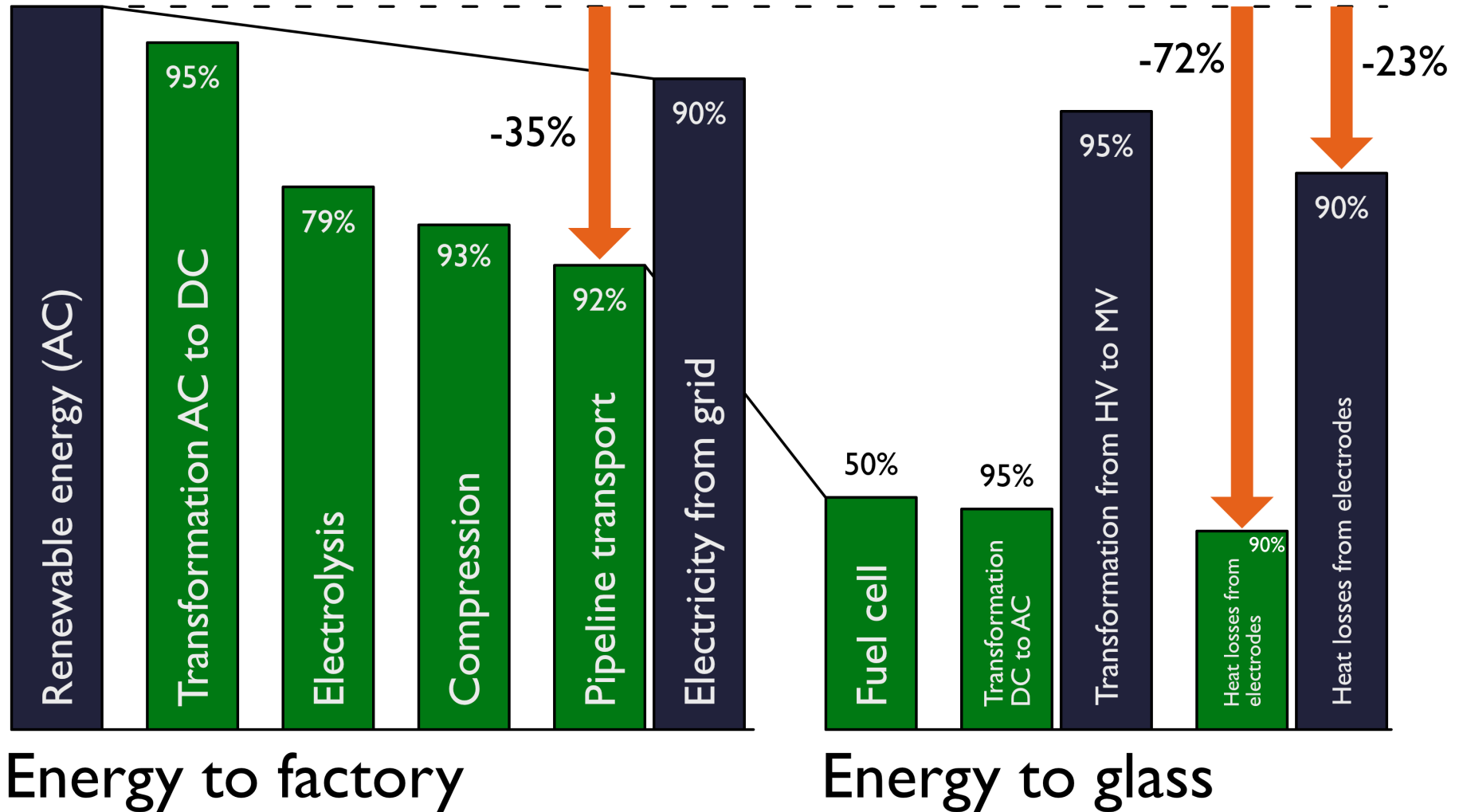



Direct
electrification



Hydrogen
for
transport

*area corresponds to available energy

- High-temperature **heat pumps** can be used for cullet pre-heating, e.g., during peak supply hours. Cullet preheating up to 200°C

The cullet preheater acts as a thermal storage.

- The company *Electrified Thermal Solutions* developed **conductive refractory bricks** that can transform electric energy into thermal energy. The bricks can heat up to 1800 °C. In a regenerator-like structure, this technology could supply energy with high temperatures.

During peak supply hours, the thermal battery can be charged.

- **Plasma burners** use electricity to generate flame temperatures of more than 10,000 °C.
- **Gyrotrons** generate high-power, high-frequency THz radiation. The radiation directly interacts with the material and can heat up rock up to 3000 °C

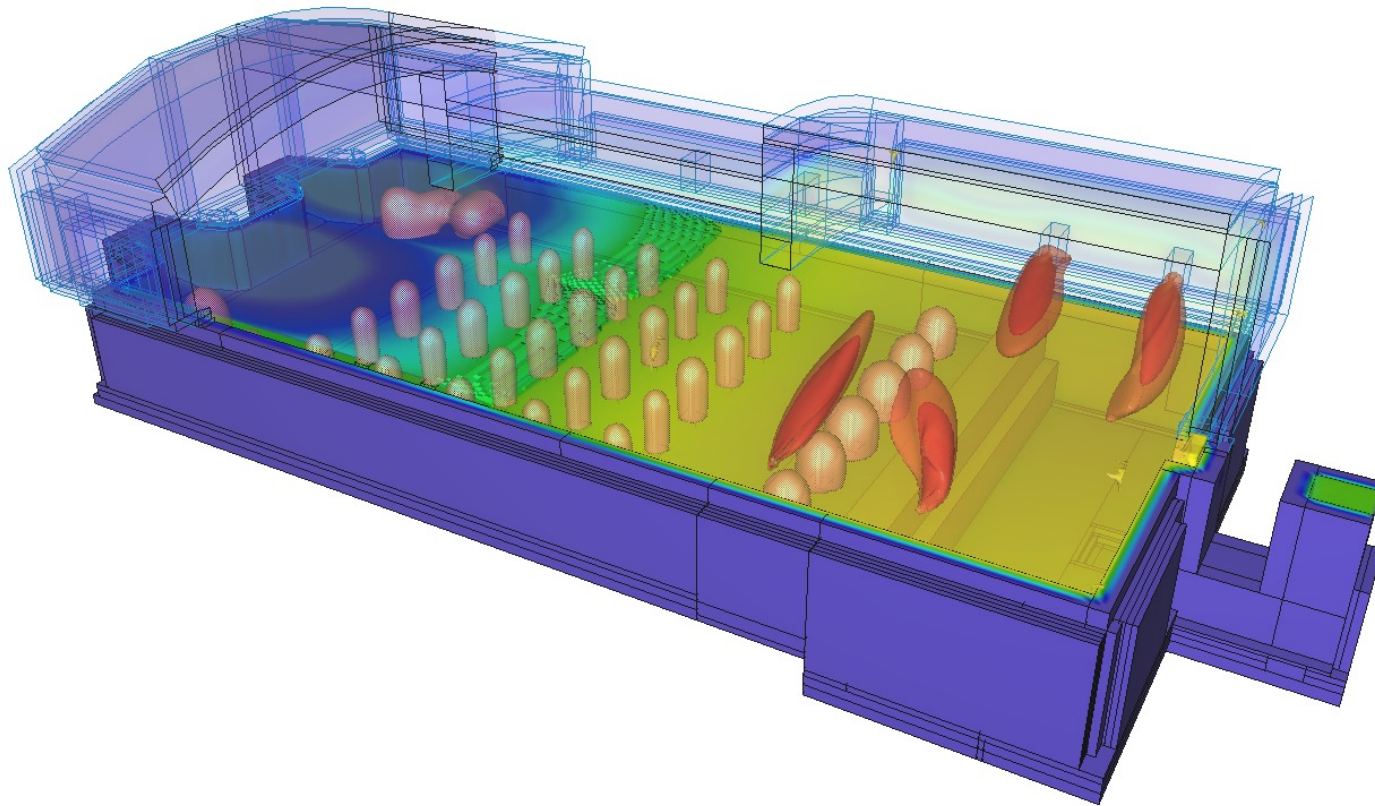

- The world is transforming from fossil fuels to electric power. Electricity, especially from renewable energy, will be the cheapest form of energy. Due to conversion losses, other energy carriers will be more expensive.
- Hydrogen will play only a minor role in the glass industry.
- Custom furnace designs are needed to adopt to local energy sources/carriers.
- Technologies that utilize electric energy must be investigated.
- Simulation helps to understand new technologies and to design new furnaces.

Thank you!

Questions?



Malte Sander

Glass Service

www.gsl.cz

malte.sander@glass-service.eu